

Datasheet

Self-Contained Adjustable-Field Sensors

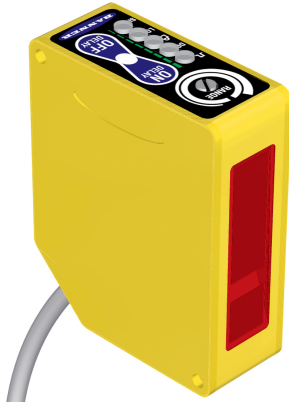

- Adjustable-field background suppression sensor detects objects within a defined sensing field, while ignoring objects located beyond the sensing field cutoff
- Two-turn, logarithmic adjustment of sensing field cutoff point from 0.2 m to 1 m (7.9 in to 3.3 ft); allows easy setting of cutoff point at long range
- Rotating pointer indicates relative cutoff point setting
- Easy push-button or remote programming of light/dark operate and output timing; continuous status indicators verify all settings at a glance
- Output ON and/or OFF delays adjustable from 8 milliseconds to 16 seconds
- Powerful, highly collimated visible red sensing beam
- Tough ABS/polycarbonate blend housing is rated IP67; NEMA 6

10 V DC to 30 V DC Models (Q60BB6AFV):

- Powered by 10 V DC to 30 V DC; bipolar (one NPN and one PNP) outputs
- Available with integral cable or rotating Euro-style quick-disconnect fitting

Universal Voltage Models (Q60VR3AFV):

- 12 V DC to 250 V DC or 24 V AC to 250 V AC, 50/60 Hz
- Available with integral cable or rotating 1/2 in-20UNF quick-disconnect fitting



WARNING:

- **Do not use this device for personnel protection**
- Using this device for personnel protection could result in serious injury or death.
- This device does not include the self-checking redundant circuitry necessary to allow its use in personnel safety applications. A device failure or malfunction can cause either an energized (on) or de-energized (off) output condition.

Models

| Models | Minimum Range | Cutoff Point | Cable ¹ | Supply Voltage | Output Type |
|------------------------|--|--|-----------------------|---|--|
| Q60BB6AFV1000 | 65 mm to 130 mm (2.5 in to 5 in) depending on cutoff point setting | Adjustable: 200 mm to 1000 mm (8 in to 40 in) | 5-wire 2 m (6.5 ft) | 10 V DC to 30 V DC | Bipolar NPN/PNP |
| Q60BB6AFV1000Q | | | 5-pin M12 QD | | |
| Q60VR3AFV1000 | | | 5-wire 2 m (6.5 ft) | Universal Voltage 12 V DC to 250 V DC or 24 V AC to 250 V AC | E/M Relay (SPDT), normally closed and normally open contacts |
| Q60VR3AFV1000Q1 | | | 4-pin 1/2 in-20UNF QD | | |

Overview

The Q60AFV sensor is a full-featured adjustable-field sensor. These adjustable-field sensors are able to detect objects of relatively low reflectivity, while ignoring other objects in the background (beyond the cutoff point). The cutoff distance is mechanically adjustable, using the 2-turn adjustment screw on the top of the sensor. A rotating pointer indicates the relative cutoff position. The indicator moves clockwise to show increasing distance.

Two push buttons (ON Delay and OFF Delay) are used to set the output delay options, to toggle between light and dark operate modes and to lock out the push buttons for security purposes. These functions also may be accomplished using the remote wire (available on some models).

Seven LED indicators show, during RUN mode, the sensor configuration and operating status. During Delay Configuration, 5 of the LEDs combine to form a single light bar that indicates relative ON or OFF delay time.



Note: When an object approaches from the side, the most reliable sensing usually occurs when the line of approach is parallel to the sensing axis.

¹ To order the 9 m (30 ft) PVC cable model, add the suffix "W/30" to the cabled model number. For example, Q60BB6AFV1000 W/30. Models with a quick disconnect require a mating cordset.



Features and Indicators



Note: Outputs are active during on/off timing selection mode.

ON Delay

- Steady Green: Run mode, ON delay is active
- Flashing Green: ON Delay Selection mode is active

OFF Delay

- Steady Green: Run mode, OFF delay is active
- Flashing Green: OFF Delay Selection mode is active

5-Segment Light Bar²

Indicates relative delay time during ON or OFF Delay Selection modes

Output Indicator

- Steady Amber: Outputs are conducting
- Steady Green: During ON/OFF Delay Selection modes

Dark Operate Indicator

- Steady Green: Dark Operate is selected

Lockout Indicator

- Steady Green: Buttons are locked out

Light Operate Indicator

- Steady Green: Light Operate is selected

Signal Indicator

- Steady Green: Sensor is receiving signal
- Flashing Green: Marginal signal (1.0 to 2.25 excess gain)

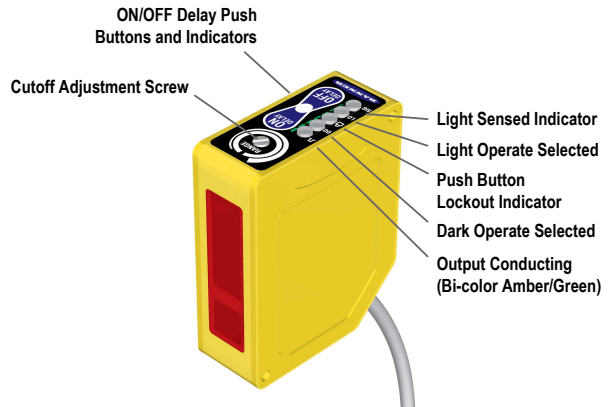

The indicators also function as a 5-segment light bar during delay selection modes

Adjustable-Field Sensing—Theory of Operation

The Q60AFV compares the reflections of its emitted light beam (E) from an object back to the sensor's two differently-aimed detectors R1 and R2 (see [Figure 1](#) on p. 2). If the near detector (R1) light signal is stronger than the far detector (R2) light signal (see object A, closer than the cutoff distance), the sensor responds to the object. If the far detector (R2) light signal is stronger than the near detector (R1) light signal (see object B, object beyond the cutoff distance), the sensor ignores the object.

The cutoff distance for these sensors is adjustable. Objects lying beyond the cutoff distance are ignored, even if they are highly reflective. However, it is possible to falsely detect a background object, under certain conditions (see [Background Reflectivity and Placement](#) on p. 4).

Figure 1. Adjustable field sensing concept

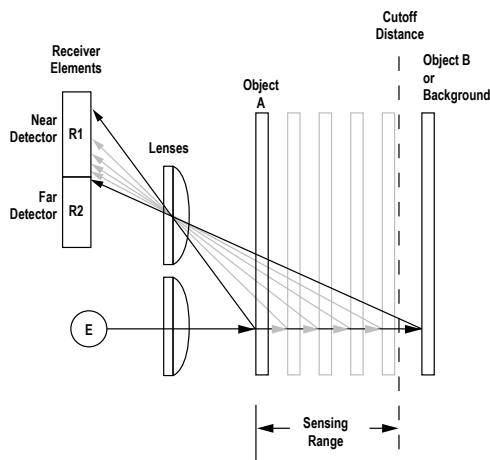
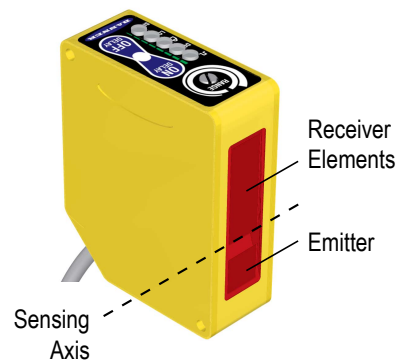

Figure 2. Sensing Axis



In the drawings and information provided in this document, the letters E, R1, and R2 identify how the sensor's three optical elements (Emitter "E", Near Detector "R1", and Far Detector "R2") line up across the face of the sensor. The location of these elements defines the sensing axis (see [Figure 2](#) on p. 2). The sensing axis becomes important in certain situations, such as in the Object Beyond Cutoff illustrations in [Background Reflectivity and Placement](#) on p. 4.

² Output, Dark Operate, Lockout, Light Operate and Signal indicators function as 5-Segment Light Bar during ON or OFF Delay Selection modes

Installation

Wiring Diagrams

Q60BB6xx(Q)
Cabled and QD Models, 10 V DC to 30 V DC

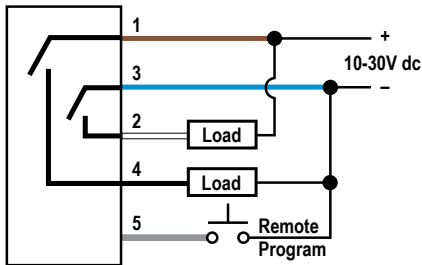

Q60VR3xx
Cabled Model, 24 V AC to 250 V AC (50/60Hz) or 12 V DC to 250 V DC

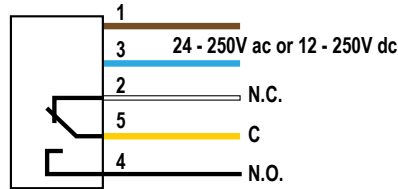

Key
1 = Brown
2 = White
3 = Blue
4 = Black
5 = Gray

Q60VR3xxQ1
QD Model, 24 V AC to 250 V AC (50/60Hz) or 12 V DC to 250 V DC

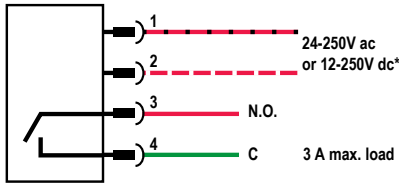

Key
1 = Red/Black
2 = Red/White
3 = Red
4 = Green

*NOTE: Connection of dc power is without regard to polarity.

Set the Cutoff Distance

The cutoff distance for Q60AFV sensors can be adjusted between 200 mm to 1000 millimeters (8 in to 40 in).

To maximize contrast, position the lightest possible background to be used, at the closest position it will come to the sensor during use. Using a small screwdriver in the adjustment screw, adjust the cutoff distance until the threshold is reached and the green Light Sensed indicator changes state. If the indicator never turns ON, the background is beyond the maximum sensing cutoff and will be ignored. Note the position of the rotating cutoff position indicator at this position. Then repeat the procedure, using the darkest target, placed in its most distant position for sensing. Adjust the cutoff so that the indicator is midway between the two positions.

Figure 3. Set the cutoff distance approximately midway between the farthest target and the closest background

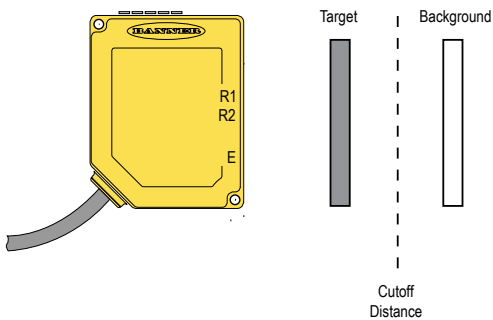
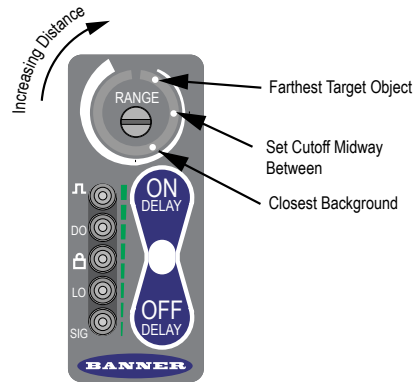

Figure 4. Setting the cutoff distance



Note: Setting the cutoff distance adjustment screw to its maximum clockwise position places the receiver lens directly in front of the receiver elements and results in the Q60 performing as a long-range diffuse sensor.

Sensing Reliability

For highest sensitivity, the sensor-to-object distance should be such that the object will be sensed at or near the point of maximum excess gain. The excess gain curves show excess gain versus sensing distance for 200 mm and 1 m cutoffs. Maximum excess gain for a 200 mm cutoff occurs at a lens-to-object distance of about 150 mm, and for a 1 m cutoff, at about 400 mm. The background must be placed beyond the cutoff distance. Following these two guidelines makes it possible to detect objects of low reflectivity, even against close-in reflective backgrounds.

Background Reflectivity and Placement

Avoid mirror-like backgrounds that produce specular reflections. A false sensor response occurs if a background surface reflects the sensor's light more to the near detector (R1) than to the far detector (R2). The result is a false ON condition (Figure 5 on p. 4). Correct this problem by using a diffusely reflective (matte) background, or angling either the sensor or the background (in any plane) so the background does not reflect light back to the sensor (Figure 6 on p. 4). Position the background as far beyond the cutoff distance as possible.

An object beyond the cutoff distance, either stationary (and when positioned as shown in Figure 7 on p. 4), or moving past the face of the sensor in a direction perpendicular to the sensing axis, may cause unwanted triggering of the sensor if more light is reflected to the near detector than to the far detector. Correct the problem by rotating the sensor 90° (Figure 8 on p. 4). The object then reflects the R1 and R2 fields equally, resulting in no false triggering. A better solution, if possible, may be to reposition the object or the sensor.

Figure 5. Reflective Background - Problem

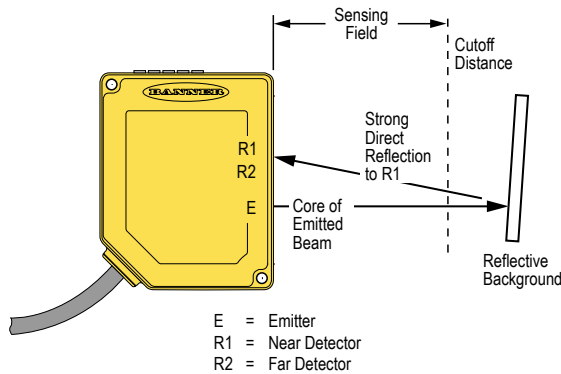

Figure 6. Reflective Background - Solution

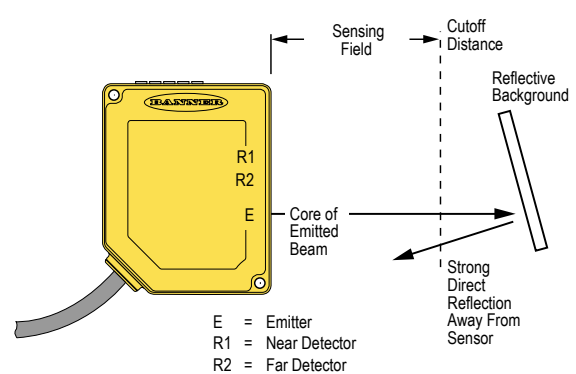
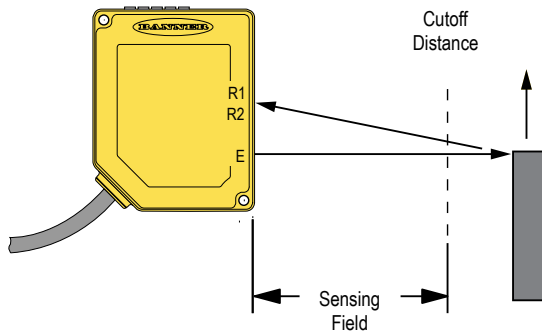
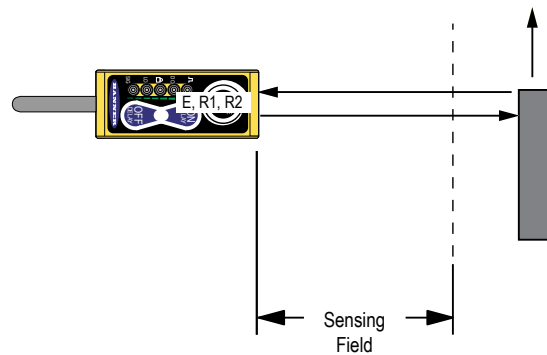

Figure 7. Object Beyond Cutoff - Problem



A reflective background object in this position or moving across the sensor face in this axis and direction may cause a false sensor response.

Figure 8. Object Beyond Cutoff - Solution



A reflective background object in this position or moving across the sensor face in this axis is ignored.

Color Sensitivity

The effects of object reflectivity on cutoff distance, though small, may be important for some applications. It is expected that at any given cutoff setting, the actual cutoff distance for lower reflectance targets is slightly shorter than for higher reflectance targets. This behavior is known as color sensitivity.

These excess gain curves were generated using a white test card of 90% reflectance. Objects with reflectivity of less than 90% reflect less light back to the sensor, and thus require proportionately more excess gain in order to be sensed with the same reliability as more reflective objects. When sensing an object of very low reflectivity, it may be especially important to sense it at or near the distance of maximum excess gain.

The percentage of deviation indicates a change in the cutoff point for either 18% gray or 6% black targets, relative to the cutoff point set for a 90% reflective white test card.

For example, the cutoff point decreases 4% for a 6% reflectance black target when the cutoff point is adjusted for 1000 mm (40 in) using a 90% reflectance white test card. In other words, the cutoff point for the black target is 960 mm (38 in) for this setting.

Figure 9. Cutoff Point Deviation

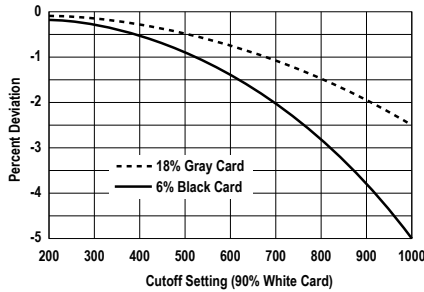

Figure 10. Q60 Minimum Range Versus Cutoff Setting

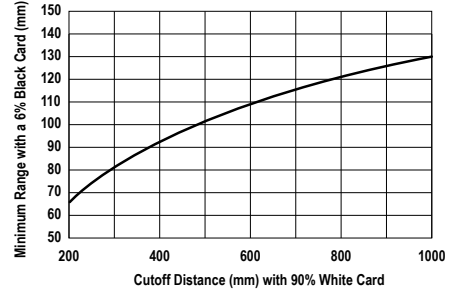
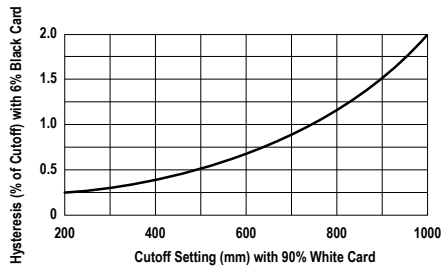

Figure 11. Hysteresis



Configuring a Sensor

Set the Output Delay

The output of the Q60AFV sensor may be delayed between 0.008 and 16 seconds, in any of 72 increments. Delay is indicated on the 5-segment light bar using single LED segments or combinations of them, in varying stages of intensity.

To set a delay, single-click the appropriate button or pulse the remote wire to enable the process (as described in the following procedures). Then use the + or – button or the appropriate remote wire pulse procedure to increase or decrease the delay (single-click adjusts the delay by one step at a time, and holding the button in provides a rapid increase/decrease).



Note: Remote wire available on models Q60BB6AFV(Q) only.

Major increments, displayed by a single full-intensity LED, are shown:



| Step # | Delay Time | LED Status |
|--------|--------------|------------|
| 0 | No Delay | |
| 8 | 0.062 second | |
| 24 | 0.250 second | |
| 40 | 1.00 second | |
| 56 | 4.0 seconds | |
| 72 | 16 seconds | |

Increase or Decrease the ON Delay



T = 40 – 800 ms

Press and Hold > 800 ms unless otherwise noted

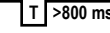
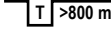
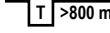
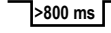
Increase the ON Delay—4-second time-out

| | Enter ON Delay Setup | Enable Delay Increment | Step Increment | Rapid Increment |
|--------------|---|---|---|---|
| Push Button |  | N/A |  |  |
| Remote Input |  |  |  |  |

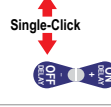
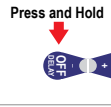
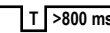
Decrease the ON Delay—4-second time-out

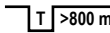
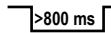

| | Enter ON Delay Setup | Enable Delay Decrement | Step Decrement | Rapid Decrement |
|--------------|---|---|---|---|
| Push Button |  | N/A |  |  |
| Remote Input |  |  |  |  |

Increase or Decrease the OFF Delay

T = 40 – 800 ms

Press and Hold > 800 ms unless otherwise noted

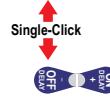
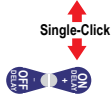
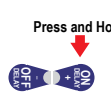
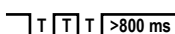
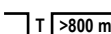
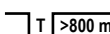
Increase the OFF Delay—4-second time-out

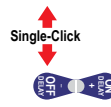
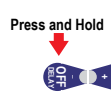
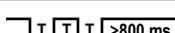
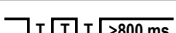
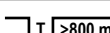
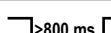

| | Enter OFF Delay Setup | Enable Delay Increment | Step Increment | Rapid Increment |
|--------------|---|---|---|---|
| Push Button |  | N/A |  |  |
| Remote Input |  |  |  |  |

Decrease the OFF Delay—4-second time-out

| | Enter OFF Delay Setup | Enable Delay Decrement | Step Decrement | Rapid Decrement |
|--------------|---|---|---|---|
| Push Button |  | N/A |  |  |
| Remote Input |  |  |  |  |

Select Light Operate or Dark Operate

Select Light Operate or Dark Operate mode using the two push buttons or a 4-second pulse of the remote line to toggle between the selections.

| | LO/DO Toggle |
|--------------|---|
| Push Button |  |
| Remote Input |  |

Lock the Push Buttons

For security, the push buttons can be locked out using either the remote line or the push buttons themselves.

| Push Button Lockout Toggle | |
|----------------------------|--|
| Push Button | |
| Remote Input | |

Specifications

Supply Voltage and Current

Q60BB6AFV models: 10 V DC to 30 V DC (10% maximum ripple) at less than 50 mA exclusive of load
 Q60VR3AFV Universal models: 12 V DC to 250 V DC or 24 V AC to 250 V AC, 50/60 Hz

Supply Protection Circuitry

Protected against reverse polarity and transient voltages
 The dc wiring for model Q60VR3 is without regard to polarity

Output Configuration

Q60BB6AFV models: Bipolar; one NPN (current sinking) and one PNP (current sourcing) open-collector transistor
 Q60VR3AFV cabled model: E/M Relay (SPDT), normally closed and normally open contacts
 Q60VR3AFVQ1 (QD) model: E/M Relay (SPST), normally open contact

Output Rating—Q60BB6AFV models

150 mA maximum each output @ 25 °C
 Off-state leakage current: < 5 µA @ 30 V DC
 Output saturation NPN: < 200 mV @ 10 mA and < 1 V @ 150 mA
 Output saturation PNP: < 1 V at 10 mA; < 1.5 V at 150 mA

Output Rating—Q60VR3AFV Universal models

Minimum voltage and current: 5 V DC, 10 mA
 Mechanical life of relay: 50,000,000 operations
 Electrical life of relay at full resistive load: 100,000 operations
 Maximum switching power (resistive load):

Cabled models: 1250 VA, 150 W
 QD models: 750 VA, 90 W

Maximum switching voltage (resistive load):

Cabled models: 250 V AC, 125 V DC
 QD models: 250 V AC, 125 V DC

Maximum switching current (resistive load):

Cabled models: 5 A @ 250 V AC, 5 A @ 30 V DC derated to 200 mA @ 125 V DC
 QD models: 3 A @ 250 V AC, 3 A @ 30 V DC derated to 200 mA @ 125 V DC

Output Protection Circuitry

Q60BB6AFV models: Protected against continuous overload or short circuit of outputs
 All models: Protected against false pulse on power-up

Output Response Time

Q60BB6AFV models: 2 milliseconds ON and OFF



Note: 150 millisecond delay on power-up; outputs do not conduct during this time.

Q60VR3AFV Universal models: 15 milliseconds ON and OFF



Note: 150 millisecond delay on power-up; relay is de-energized during this time.

Repeatability

500 microseconds

Sensing Hysteresis

See [Color Sensitivity](#) on p. 4

Adjustments

Slotted, geared, 2-turn, cutoff range adjustment screw (mechanical stops on both ends of travel)
 2 momentary push buttons: ON Delay (+) and OFF Delay (-); DC models also have a remote program wire

ON Delay select: 8 ms to 16 seconds

OFF Delay select: 8 ms to 16 seconds

LO/DO select

Push button lockout for security

Construction

Housing: ABS polycarbonate blend

Lens: Acrylic

Cover: Clear ABS

Environmental Rating

IP67; NEMA 6

Connections

2 m (6.5 ft) or 9 m (30 ft) attached cable, 5-pin M12 fitting, or 5-pin 7/8 in-16UNF 150 mm (6 in) QD, depending on model. QD cables are ordered separately

Operating Conditions

Temperature: -20 °C to +55 °C (-4 °F to +131 °F)

90% at +50 °C maximum relative humidity (non-condensing)

Required Overcurrent Protection



WARNING: Electrical connections must be made by qualified personnel in accordance with local and national electrical codes and regulations.

Overcurrent protection is required to be provided by end product application per the supplied table.

Overcurrent protection may be provided with external fusing or via Current Limiting, Class 2 Power Supply.

Supply wiring leads < 24 AWG shall not be spliced.

For additional product support, go to www.bannerengineering.com.

| Supply Wiring (AWG) | Required Overcurrent Protection (Amps) |
|---------------------|--|
| 20 | 5.0 |
| 22 | 3.0 |
| 24 | 2.0 |
| 26 | 1.0 |
| 28 | 0.8 |
| 30 | 0.5 |

Certifications



Dimensions

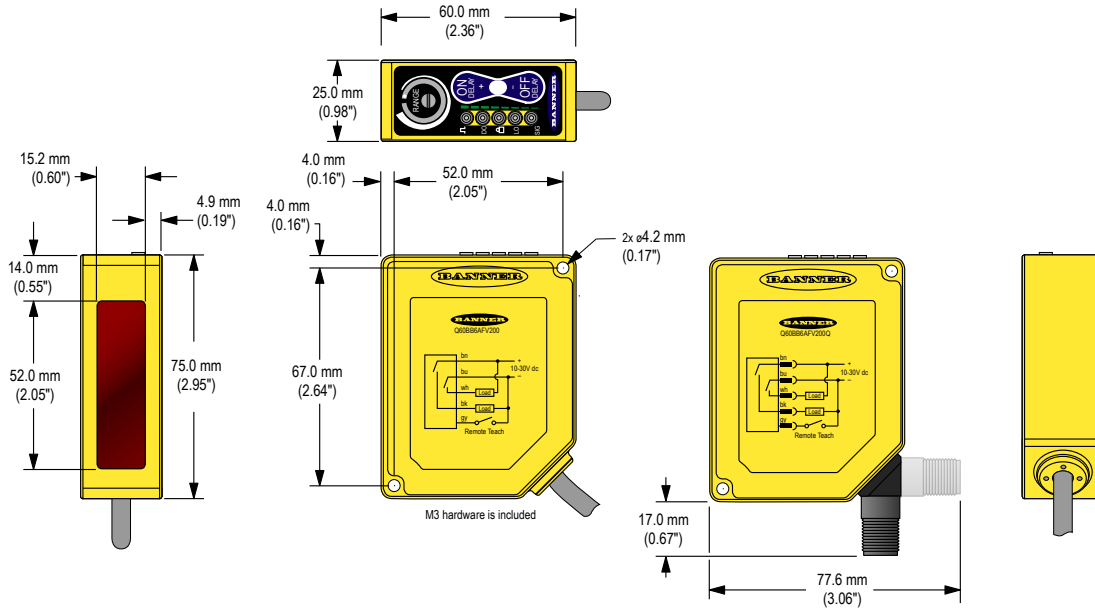

Performance Curves

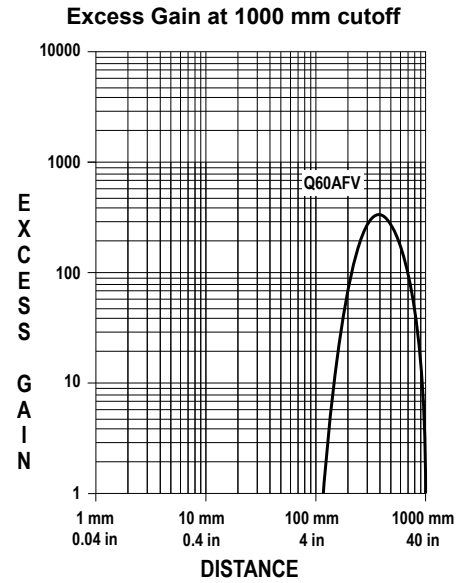
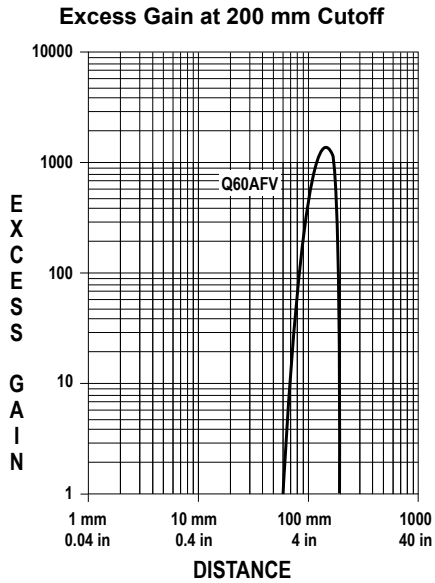

Accessories

Cordsets

| 4-Pin 1/2-in Dual Key Cordsets—Single Ended | | | | |
|---|----------------|-------------|------------|--|
| Model | Length | Style | Dimensions | Pinout (Female) |
| MQAC-406 | 2 m (6.56 ft) | Straight | | <p>1 = Red/Black 2 = Red/White 3 = Red 4 = Green</p> |
| MQAC-415 | 5 m (16.4 ft) | | | |
| MQAC-430 | 9.14 m (30 ft) | | | |
| MQAC-406RA | 1.83 m (6 ft) | Right-Angle | | |
| MQAC-415RA | 5 m (16.4 ft) | | | |
| MQAC-430RA | 9.14 m (30 ft) | | | |

| 5-Pin Threaded M12 Cordsets—Single Ended | | | | |
|--|----------------|-------------|------------|--|
| Model | Length | Style | Dimensions | Pinout (Female) |
| MQDC1-501.5 | 0.5 m (1.5 ft) | Straight | | <p>1 = Brown 2 = White 3 = Blue 4 = Black 5 = Gray</p> |
| MQDC1-506 | 2 m (6.5 ft) | | | |
| MQDC1-515 | 5 m (16.4 ft) | | | |
| MQDC1-530 | 9 m (29.5 ft) | Right-Angle | | |
| MQDC1-506RA | 2 m (6.5 ft) | | | |
| MQDC1-515RA | 5 m (16.4 ft) | | | |
| MQDC1-530RA | 9 m (29.5 ft) | | | |

Brackets

SMBQ60

- Right-angle bracket
- 14-gauge 304 stainless steel

